

CN9130 CP0 MPPs

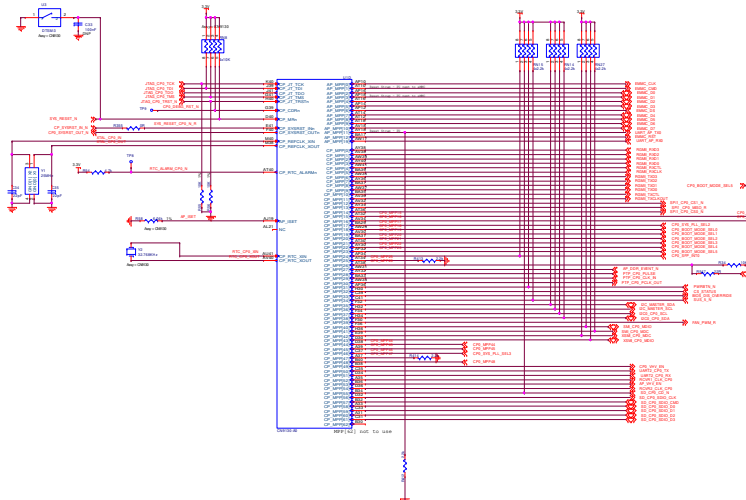

CN9130 MoCi

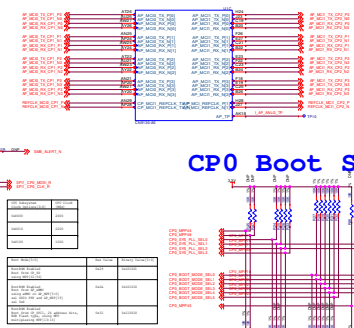

CN9130 SERDES



CP0 Boot Straps

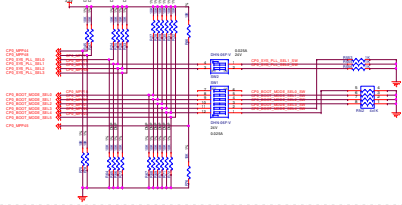

Signal	Pin	Function
CP0_BOOT_STRAP_0	1	CP0_BOOT_STRAP_0
CP0_BOOT_STRAP_1	2	CP0_BOOT_STRAP_1
CP0_BOOT_STRAP_2	3	CP0_BOOT_STRAP_2
CP0_BOOT_STRAP_3	4	CP0_BOOT_STRAP_3
CP0_BOOT_STRAP_4	5	CP0_BOOT_STRAP_4
CP0_BOOT_STRAP_5	6	CP0_BOOT_STRAP_5
CP0_BOOT_STRAP_6	7	CP0_BOOT_STRAP_6
CP0_BOOT_STRAP_7	8	CP0_BOOT_STRAP_7
CP0_BOOT_STRAP_8	9	CP0_BOOT_STRAP_8
CP0_BOOT_STRAP_9	10	CP0_BOOT_STRAP_9
CP0_BOOT_STRAP_10	11	CP0_BOOT_STRAP_10
CP0_BOOT_STRAP_11	12	CP0_BOOT_STRAP_11
CP0_BOOT_STRAP_12	13	CP0_BOOT_STRAP_12
CP0_BOOT_STRAP_13	14	CP0_BOOT_STRAP_13
CP0_BOOT_STRAP_14	15	CP0_BOOT_STRAP_14
CP0_BOOT_STRAP_15	16	CP0_BOOT_STRAP_15
CP0_BOOT_STRAP_16	17	CP0_BOOT_STRAP_16
CP0_BOOT_STRAP_17	18	CP0_BOOT_STRAP_17
CP0_BOOT_STRAP_18	19	CP0_BOOT_STRAP_18
CP0_BOOT_STRAP_19	20	CP0_BOOT_STRAP_19
CP0_BOOT_STRAP_20	21	CP0_BOOT_STRAP_20
CP0_BOOT_STRAP_21	22	CP0_BOOT_STRAP_21
CP0_BOOT_STRAP_22	23	CP0_BOOT_STRAP_22
CP0_BOOT_STRAP_23	24	CP0_BOOT_STRAP_23
CP0_BOOT_STRAP_24	25	CP0_BOOT_STRAP_24
CP0_BOOT_STRAP_25	26	CP0_BOOT_STRAP_25
CP0_BOOT_STRAP_26	27	CP0_BOOT_STRAP_26
CP0_BOOT_STRAP_27	28	CP0_BOOT_STRAP_27
CP0_BOOT_STRAP_28	29	CP0_BOOT_STRAP_28
CP0_BOOT_STRAP_29	30	CP0_BOOT_STRAP_29
CP0_BOOT_STRAP_30	31	CP0_BOOT_STRAP_30
CP0_BOOT_STRAP_31	32	CP0_BOOT_STRAP_31

88F8215 CP1 MPPs

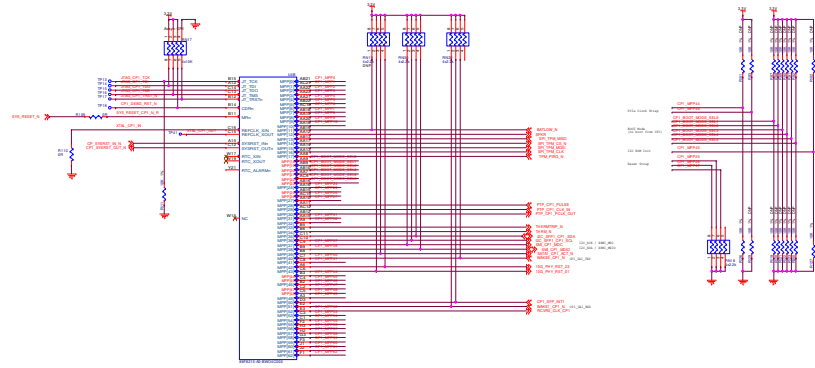

88F8215 CP1 SERDES

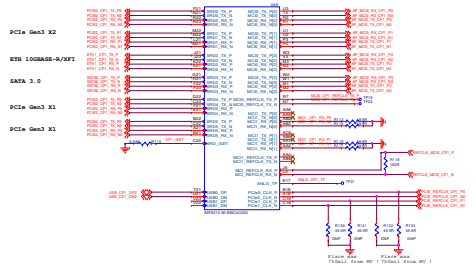

88F8215 CP2 MPPs

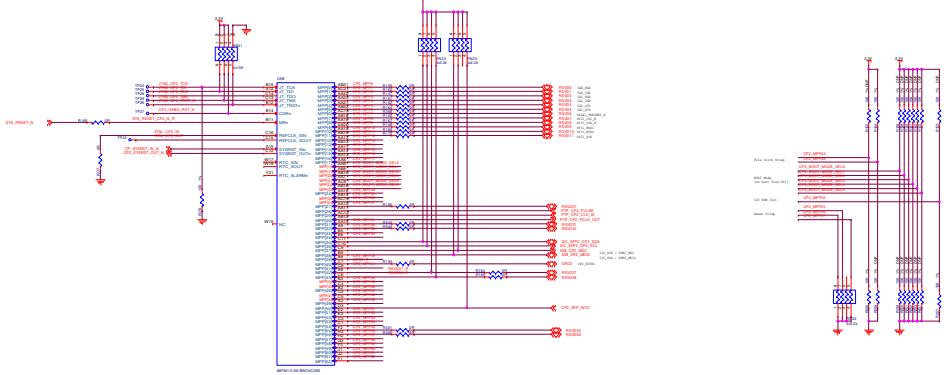

88F8215 CP2

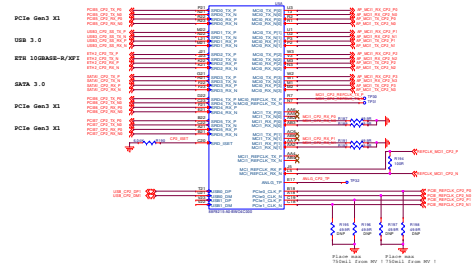

PCIe CLK GEN

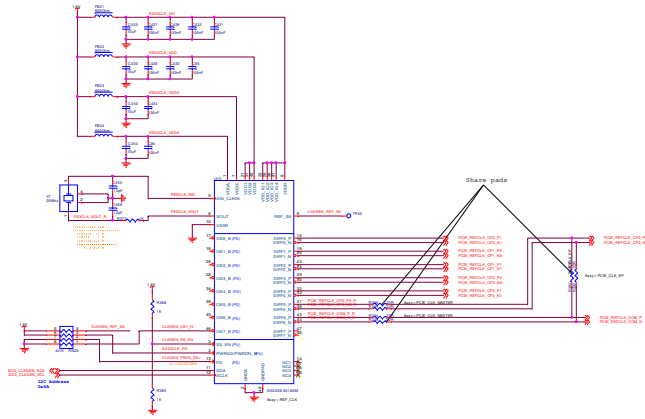

JTAG CP0 Connector

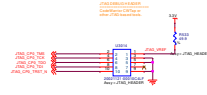

2Kbit EEPROM

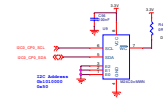

I2C Header



I2C MUX

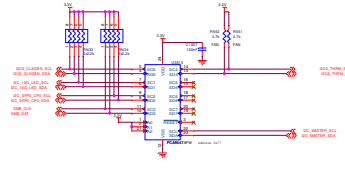

UART Header

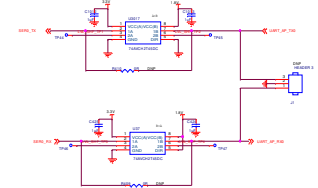

FAN Control & Thermal Sense

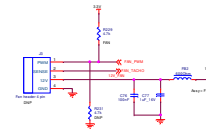

SPI NOR Flash

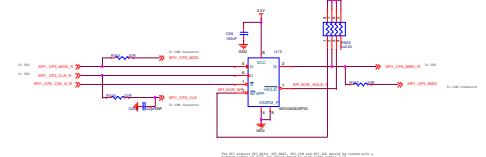

RGMI to MDI 1GE Copper

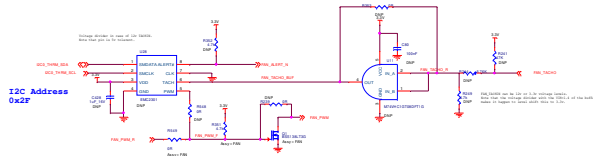
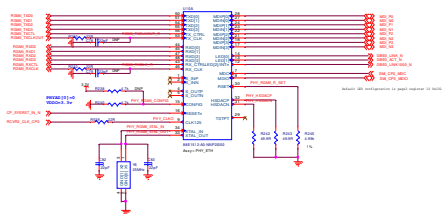

TPM

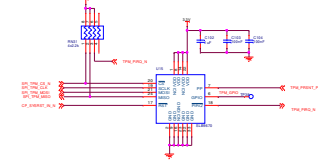

Boot SPI CS0/CS1 switch

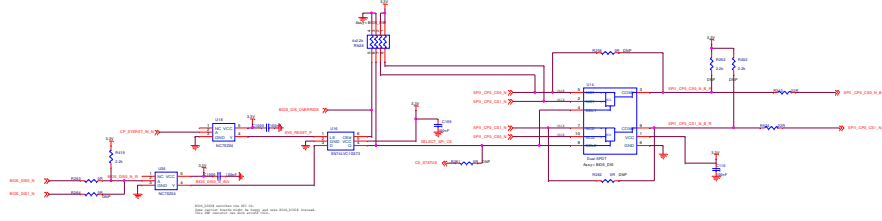

LED

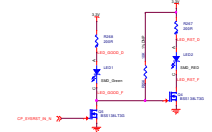

eMMC

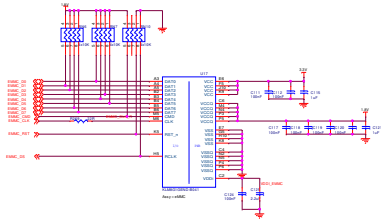

RESET Circuit

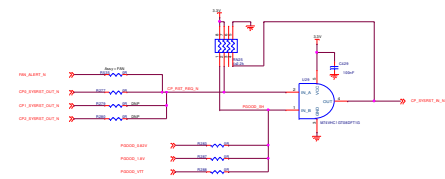

CB_RESET / PERST

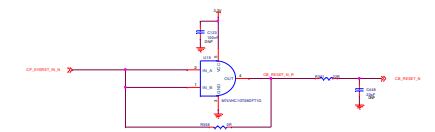

COM-EX Type7 Conn A/B

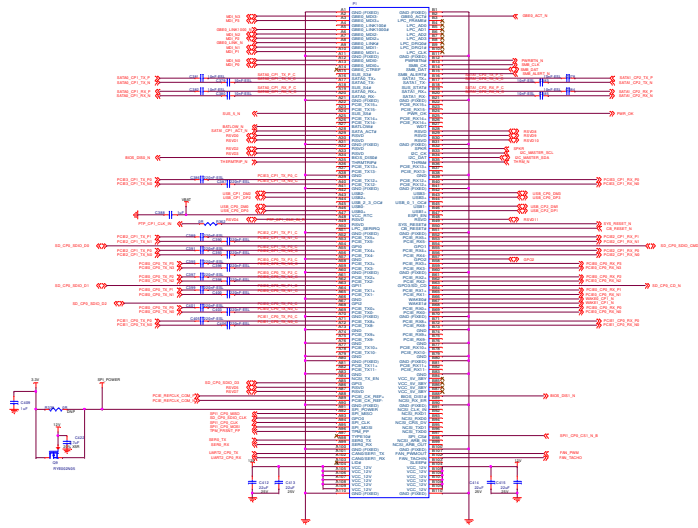

COM-EX Type7 Conn C/D

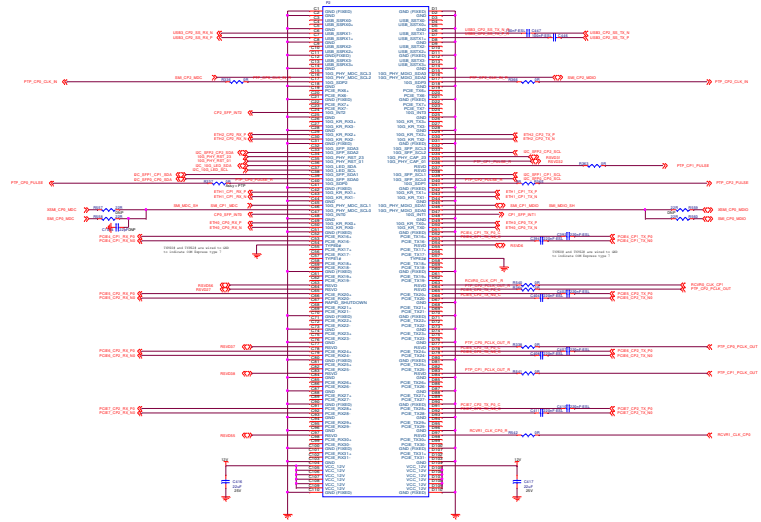

Mechanical Holes

